

■ BAD82-系列外形及安装尺寸(BAD82-X/T)

光源种类	功率(W)	安装尺寸(mm)	
		A	B
高压钠灯	70, 100, 110	450	403
	150	495	448
金卤灯	70, 100, 150	450	403
	175	495	448
高压汞灯	80, 125	450	403
	175	495	448

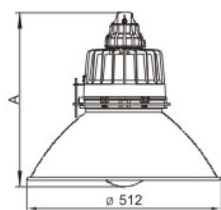

配灯伞(S)

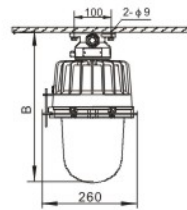

吸顶式(X)

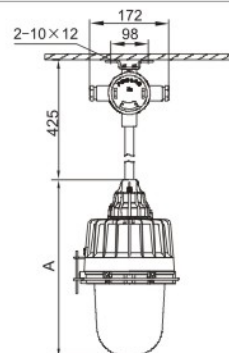

吊杆式(G)

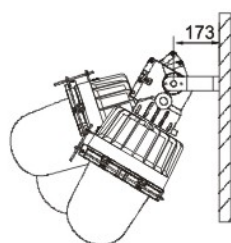

壁式(B)(30~90°可调)

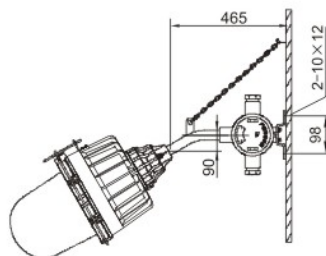

壁式(B1)30°

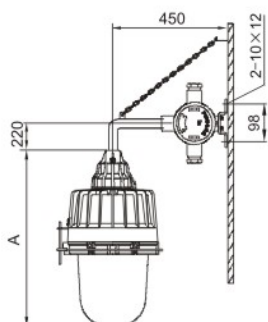

壁式(B2)90°

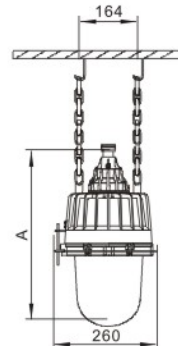

吊链式(D)

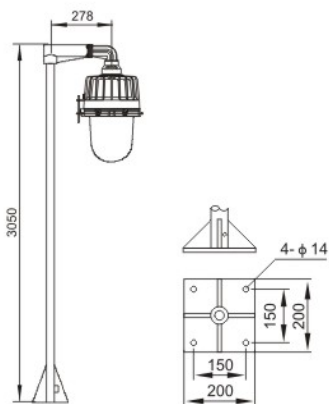

法兰式(F1)

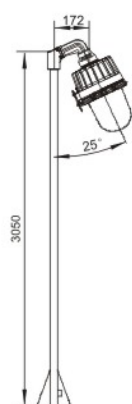

法兰式(F2)

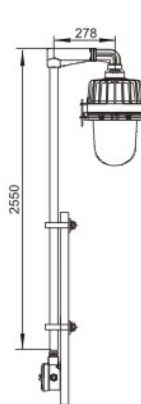

护栏式(h1)

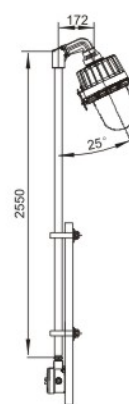

护栏式(h2)

■ BAD82-250/400外形及安装尺寸

光源种类	功率(W)	尺寸(mm)	
		A	B
高压钠灯	250	548	499
	400	572	529
金卤灯	250	548	499
	400	572	529
高压汞灯	250	548	499
	400	572	529

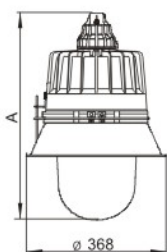

带灯伞(S)

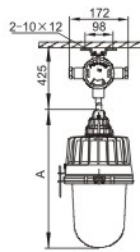

吊杆式(G)

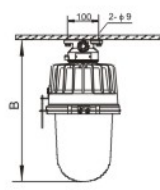

吸顶式(X)

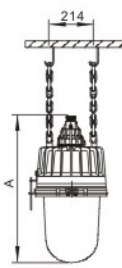

吊链式(D)